

ARGENTA SERIES

IP55 STEEL WALL-MOUNTING CABINETS

Description: IP55 ROLLED STEEL WALL-MOUNTING CABINET 1200x1200x250 DOUBLE OPAQUE DOOR

Reference:
GN12012025/PD

Characteristics:

Product type:	Wall-mounting cabinet
Dimensions cabinet:	(AxBxC) 1200x1200x250 mm
Installation:	Surface
Type of door:	Double opaque door. Reversible
Locking:	5-mm double-bit lock - One 3-points lock
Finish:	Coated with primer, and hardened polyester paint, textured, with UV protection
Colour:	RAL 7035
Mounting plate:	With flat mounting plate. 2-mm galvanised sheet steel
Weight (kg):	86,5
Materials:	Cold-rolled steel EN 10130+A1
Thickness:	Enclosure: 1,5 mm. Door: 2 mm. Cable entry lid: 2 mm.
Sealing gasket:	Injected polyurethane sealing gasket
Door material:	
Capacity:	
Max. cabinet load:	
Max. mounting plate load:	
Max. door load:	

Technical data:

Degree of protection:	IP55
NEMA degree of protection:	NEMA 1, 12
Resistance to impact:	IK10
Ambient temperature range:	-25 °C / +60 °C
Maximum operating voltage:	1000 V AC / 1500 V DC

Certificates and standards:

Directive:	2014/35/EU
Standards:	IEC 62208, IEC 61439-1
Certificates:	UL508A



Codes:

EAN:	8431044006734
Customs tariff number:	85.38.10.00
ETIM 8.0:	EC000261

ARGENTA SERIES

IP55 STEEL WALL-MOUNTING CABINETS

Description: IP55 ROLLED STEEL WALL-MOUNTING CABINET 1200x1200x250 DOUBLE OPAQUE DOOR

Reference: GN12012025/PD

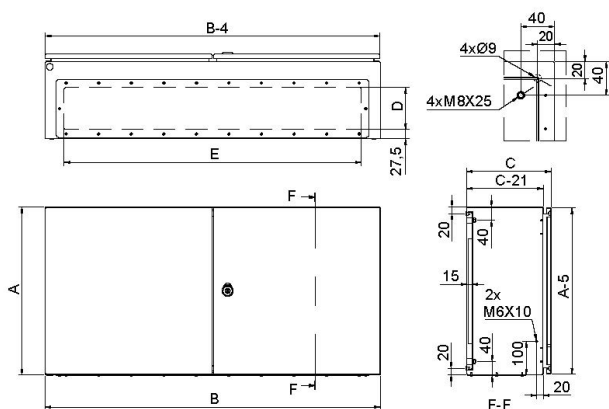

Standard drawing

Detailed drawing:  <https://www.ide.es/downloads/planos/pdf/GN12012025PD.pdf>

 <https://www.ide.es/downloads/planos/dxf/GN12012025PD.dxf>

Cable entry:	(DxE) 2x(125x485) mm
Wall fixing:	(HeightxWidth) 760x960 mm
Inside usable space:	(HeightxWidthxD) 1150x1150x229 mm
No. Hinges:	6

Body to be flush-fitted:	-
Wall fixing material:	-
Glass door with transparent panel:	-
Door profiles:	4

Sustainability:

RoHS - REACH

Supply:

Supplied in individual packaging containing cabinet, plate and accessory bag. Mounting plate is supplied assembled inside the cabinet.

Product end of life:

It does not require specific recycling operations.

Recommended applications:

Industrial environments, manufacturing companies requiring a high degree of protection against dust, splashes and impacts.