

ECOLOGY

IP65 DISTRIBUTION BOXES

Description: IP65 SURFACE BOX 1x8 MOD. (TW). ABS. N&E BARS

Reference:

CDN8PT/RR

Characteristics:

Product type:	ABS watertight distribution boxes with neutral and earth bars (Sealable)
Exterior dimensions (Height x Width x Depth):	231x238x118 mm
Dimensions of the flush-fit gap (HxWxD):	-
Number of modules:	1x8 DIN rail
Installation:	Surface
Color:	RAL 7035
Window:	Transparent
Weight (kg):	1,06
Cable entry:	Top: 4xM25 - 1xM40. Bottom: 4xM25 - 1xM40. Oblong rear: 2xOB25/25
Components:	N&E Cable section: 5x(2,5-6 mm ²)+3x(4-10 mm ²)+1x(16-35 mm ²)
Materials:	Halogen-free plastic materials. Frame and base: ABS. UV protection under ISO standard 4892-2, Method A: 500h
Lid-window-door material:	Tinted PC, UV protection

Technical data:

Degree of protection:	IP65
Resistance to impact:	IK08
Glow wire resistance:	650 °C
Ball pressure test:	70 °C
Ambient temperature range:	-25 °C / +40 °C
Maximum operating voltage:	1000 V AC / 1500 V DC
Rated current:	125A
Double insulation:	Class II

Certificates and standards:

Directive:	2014/35/EU
Standards:	IEC 62208
Certificates:	



Codes:

EAN:	8431044129327
Customs tariff number:	85.38.10.00
ETIM 8.0:	EC000214

ECOLOGY

IP65 DISTRIBUTION BOXES

Description: IP65 SURFACE BOX 1x8 MOD. (TW). ABS. N&E BARS

Reference: CDN8PT/RR

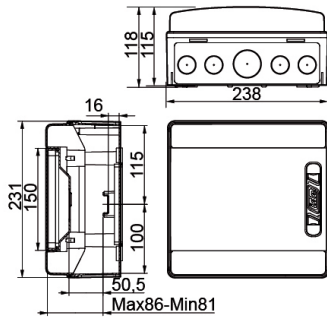

Detailed drawing:

 <http://www.ide.es/downloads/planos/pdf/CDN8PTRR.pdf>

 <http://www.ide.es/downloads/planos/dxf/CDN8PTRR.dxf>

 <http://www.ide.es/downloads/planos/stp/CDN8PTRR.stp>

Exterior dimensions (Height x Width x Depth):

231x238x118 mm

Dimensions of the flush-fit gap (Height x Width x Depth):

-

Sustainability:

RoHS - REACH

Supply:

Supplied in individual cardboard packaging. When several items are sent together, they are bundled together with transparent film.

Packaging units: 4

Product end of life:

It does not require specific recycling operations.

Recommended applications:

Industrial and outdoor environments. Industrial sites, docks, swimming pools, garages, anywhere that requires a high degree of protection against dust, splashes and impacts.