

ECOLOGY

IP65 DISTRIBUTION BOXES

Description: IP65 SURFACE BOX 1x6 MOD. (TW). ABS

Reference:
CDN6PT

Characteristics:

Product type:	ABS watertight distribution boxes (Sealable)
Exterior dimensions (Height x Width x Depth):	231x202x113 mm
Dimensions of the flush-fit gap (HxWxD):	-
Number of modules:	1x6 DIN rail
Installation:	Surface
Color:	RAL 7035
Window:	Transparent
Weight (kg):	0,92
Cable entry:	Top: 2xM25 - 1xM40. Bottom: 2xM25 - 1xM40. Oblong rear: 2xOB25/25
Components:	-
Materials:	Halogen-free plastic materials. Frame and base: ABS. UV protection under ISO standard 4892-2, Method A: 500h
Lid-window-door material:	Tinted PC, UV protection

Technical data:

Degree of protection:	IP65
Resistance to impact:	IK08
Glow wire resistance:	650 °C
Ball pressure test:	70 °C
Ambient temperature range:	-25 °C / +40 °C
Maximum operating voltage:	1000 V AC / 1500 V DC
Rated current:	
Double insulation:	Class II

Certificates and standards:

Directive:	2014/35/EU
Standards:	IEC 62208
Certificates:	



Codes:

EAN:	8431044129174
Customs tariff number:	85.38.10.00
ETIM 8.0:	EC000214

ECOLOGY

IP65 DISTRIBUTION BOXES

Description: IP65 SURFACE BOX 1x6 MOD. (TW). ABS

Reference: CDN6PT

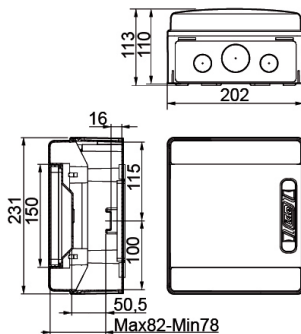

Detailed drawing:

<http://www.ide.es/downloads/planos/pdf/CDN6PT.pdf>

<http://www.ide.es/downloads/planos/dxf/CDN6PT.dxf>

<http://www.ide.es/downloads/planos/stp/CDN6PT.stp>

Exterior dimensions (Height x Width x Depth):

231x202x113 mm

Dimensions of the flush-fit gap (Height x Width x Depth):

-

Sustainability:

RoHS - REACH

Supply:

Supplied in individual cardboard packaging. When several items are sent together, they are bundled together with transparent film.

Packaging units: 6

Product end of life:

It does not require specific recycling operations.

Recommended applications:

Industrial and outdoor environments. Industrial sites, docks, swimming pools, garages, anywhere that requires a high degree of protection against dust, splashes and impacts.