

SEC. B-B

SEC. A-A

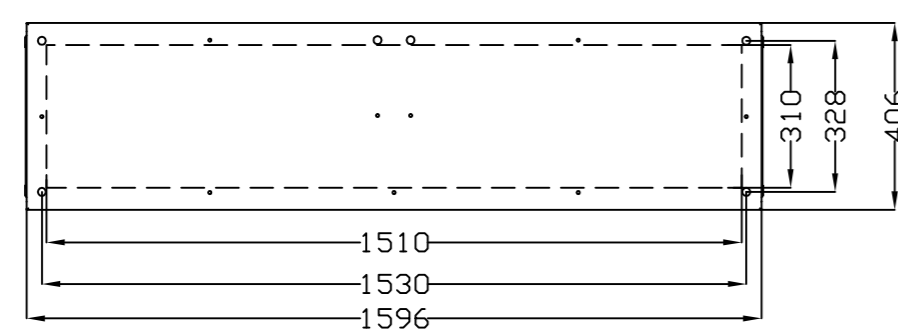

VISTA SUPERIOR
TOP VIEW

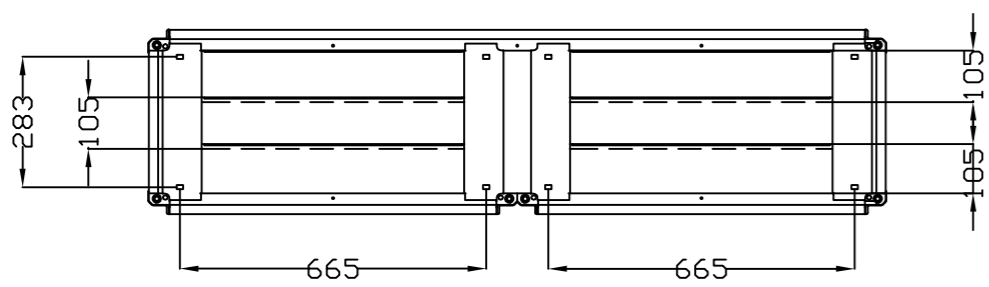

VISTA INFERIOR
BOTTOM VIEW

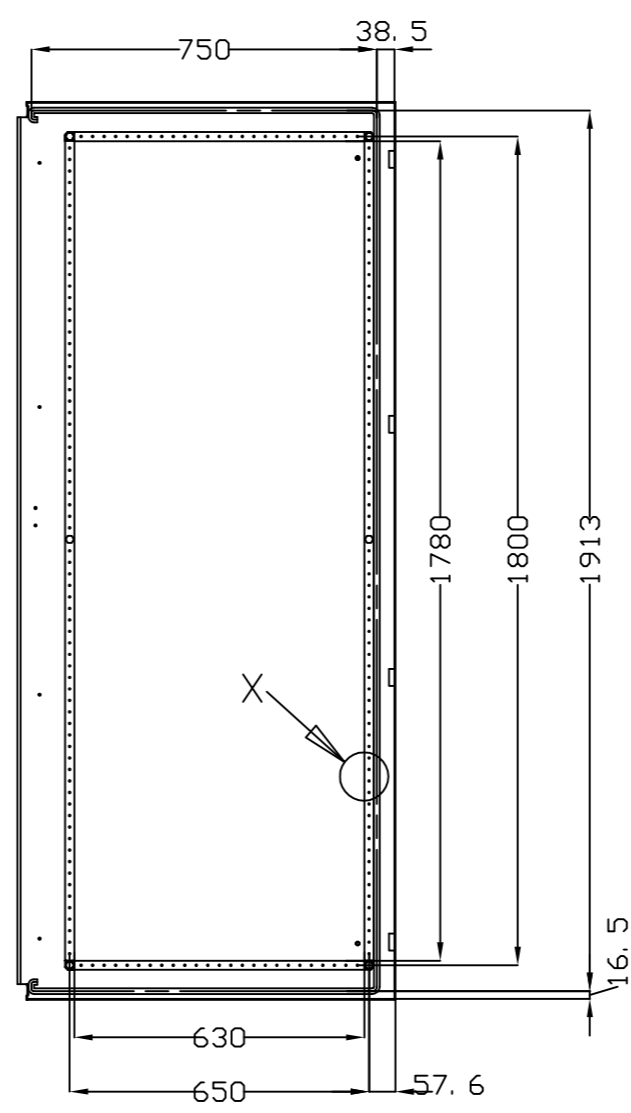
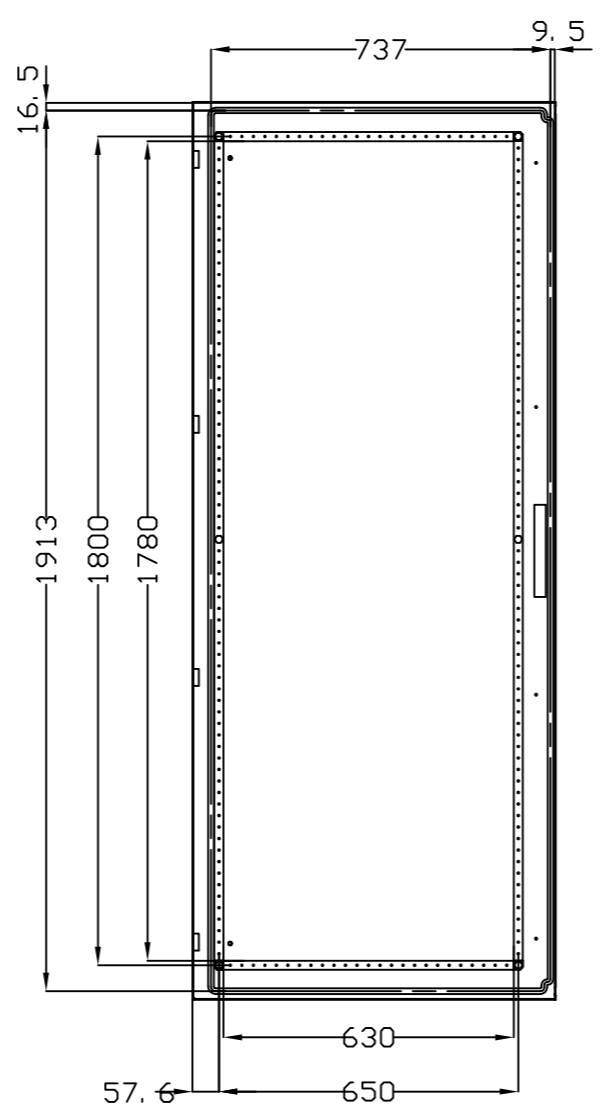

VISTA POSTERIOR PUERTA
DOOR REAR VIEW

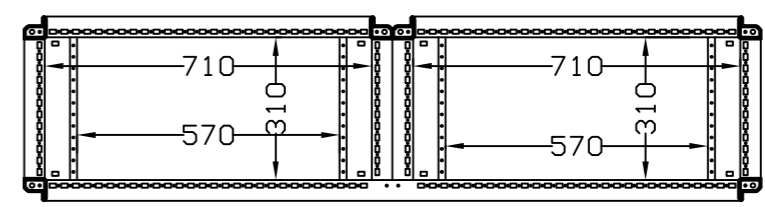

SEC. C-C

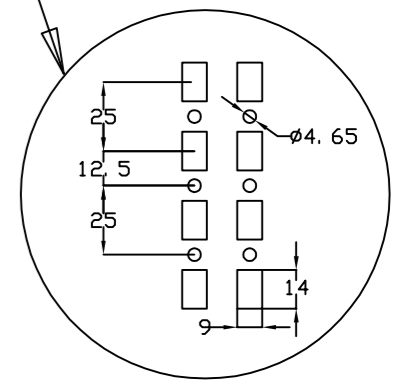

DETALLE DEL PERFIL
PROFILE DETAIL

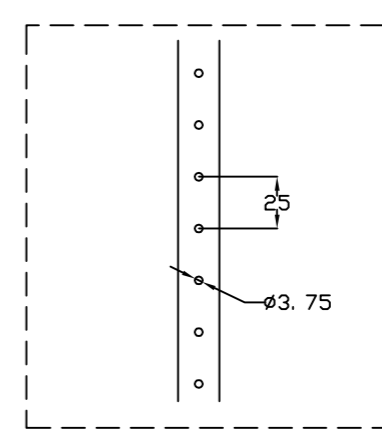

DETALLE X
X DETAIL

Queda terminantemente prohibida la reproducción o divulgación, total o parcial, de este plano sin previa autorización por escrito de I División Eléctrica S.A.
Total or partial reproduction or disclosure of this document is strictly forbidden without the prior written approval of I División Eléctrica S.A.

MODIFICADO / MODIFIED	NOMBRE / NAME	FECHA / DATE	Nº EDC. / MODIF.	DESCRIPCION DEL CAMBIO / CHANGE DESCRIPTION
FIRMA / SIGNATURE	C.VICENTE	29-Oct-2015		DESCRIPCION / DESCRIPTION
APROBADO / CHECKED	J.P. VERA	29-Oct-2015		ENL20016040PO/DC
DIBUJADO / DRAWN				
				HOJA 1 DE 1 / SHEET 1 OF 1 TAMAÑO / ESCALA / SIZE / SCALE A2 1:1
TOLERANCIAS GENERALES / GENERAL TOLERANCES EN 22768-mK				CODIGO DE PLANO / DRAWING CODE 600.06.049
PROYECTO / PROJECT ARGENTA PLUS				SUSTITUYE / REPLACE
EDICION / EDITION Nº 01				