

SEC. A-A

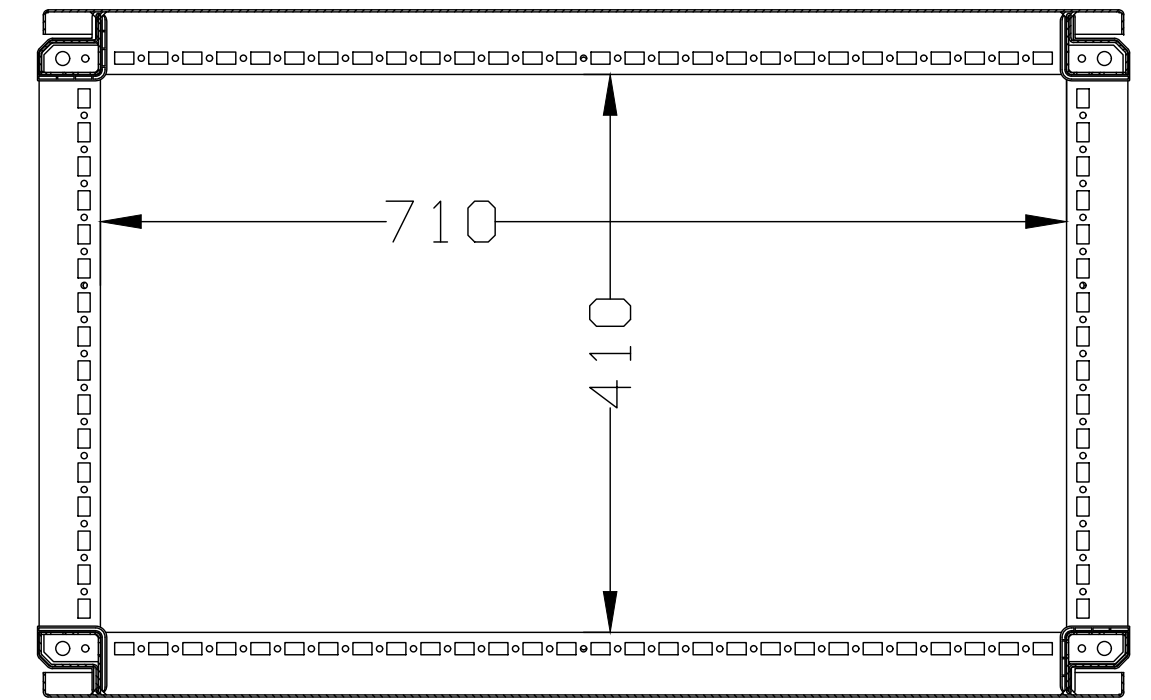

SEC. B-B

VISTA POSTERIOR PANEL FRONTAL  
FRONTAL PANEL REAR VIEW

MODIFICADO MODIFIED	NOMBRE NAME	FECHA DATE	Nº EDIC. MODIF.	DESCRIPCION DEL CAMBIO/ CHANGE DESCRIPTION	PROYECTO/PROJECT
FIRMA / SIGNATURE DIGITAL	C.VICENTE	08/07/2021		DESCRIPCION / DESCRIPTION	ARGENTA PLUS
APROBADO CHECKED	C.LÓPEZ	08/07/2021		CE408050	SUSTITUYE/ REPLACE
DIBUJADO DRAWN				CODIGO DE PLANO / DRAWING CODE	EDICION / EDITION Nº 1
		HOJA 1 DE 1 SHEET 1 OF 1	TOLERANCIAS GENERALES GENERAL TOLERANCES	600.06.624	
www.ide.es		TAMAÑO / ESCALA / SIZE / SCALE	EN 22768-mK		
		A2	1:1		